

ELECTROFUSION TEE ECCENTRIC

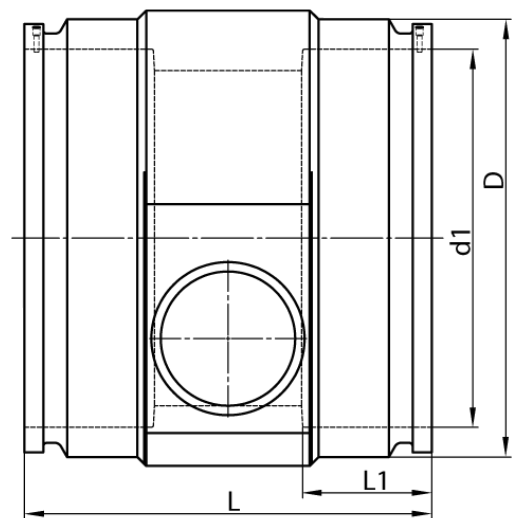

4,0 mm pin
to completely drain the pipeline

PE100-RC



SDR 17

Art. No.	d1 [mm]	d2 [mm]	D [mm]	le2 [mm]	L [mm]	L1 [mm]	z2 [mm]	kg
4332711708000090	800	90	921	150	570	235	651	100,7

Other materials, dimensions and pressure classes on request

For questions, please feel free to contact us at: Tel. + 49 281 98 414 - 0