

long spigot for butt- and electrofusion welding

PE100-RC

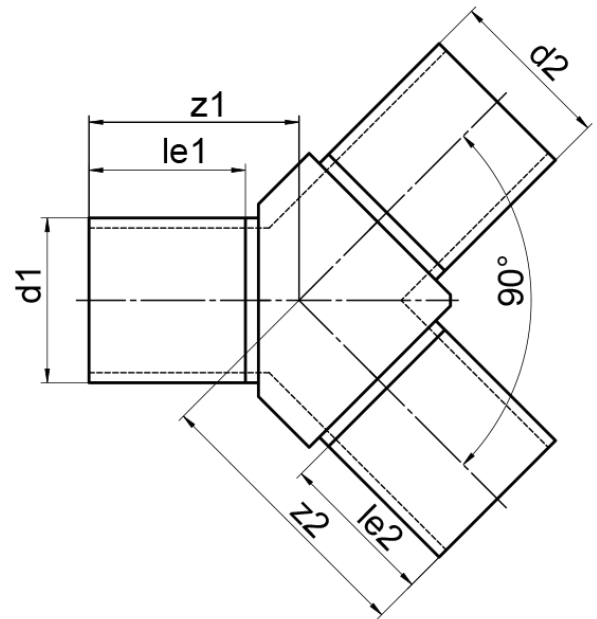

SDR 11

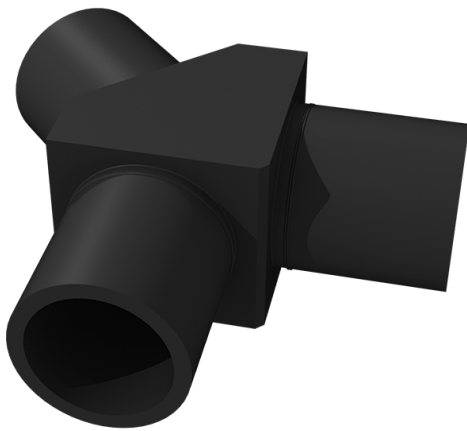

Art. No.	d1 [mm]	d2 [mm]	le1 [mm]	le2 [mm]	z1 [mm]	z2 [mm]	kg
4333201100900090	90	90	150	150	197	249	1,92

other dimensions, materials and pressure classes on request

For questions, please feel free to contact us at: Tel. + 49 281 98 414 - 0