

short spigot for butt welding  
to completely drain the pipeline

PE100-RC

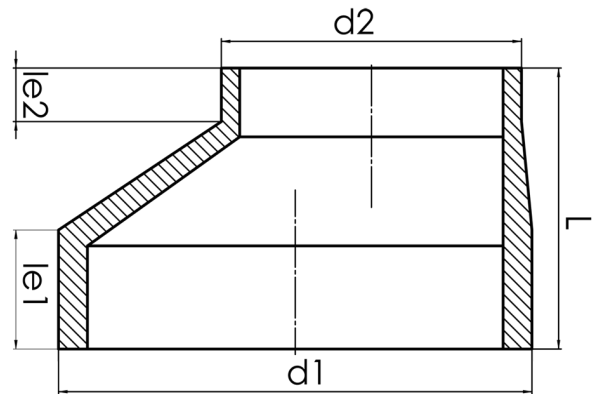

**SDR 17**



Art. No.	d1 [mm]	d2 [mm]	le1 [mm]	le2 [mm]	L [mm]	kg
4334111702800200	280	200	68	40	160	1,9

Other materials, dimensions and pressure classes on request

For questions, please feel free to contact us at: Tel. + 49 281 98 414 - 0