

short spigot for butt welding
to completely drain the pipeline

PE100-RC

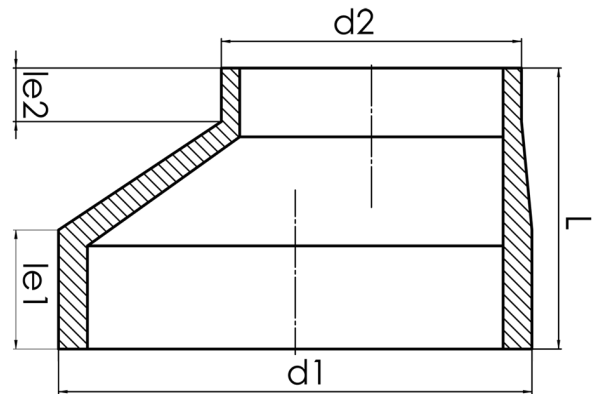

SDR 33



Art. No.	d1 [mm]	d2 [mm]	le1 [mm]	le2 [mm]	L [mm]	kg
4334113303550315	355	315	61	40	130	1,5

Other materials, dimensions and pressure classes on request

For questions, please feel free to contact us at: Tel. + 49 281 98 414 - 0