

two separate welding zones
4,0 mm pin

PE100-RC

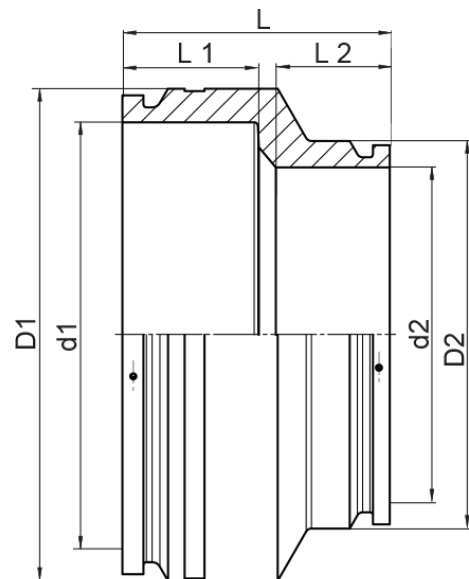

SDR 11



Art. No.	d1 [mm]	d2 [mm]	D1 [mm]	D2 [mm]	L [mm]	L1 [mm]	L2 [mm]	kg
4334561104500355	450	355	560	437	330	175	145	22,83

Other materials, dimensions and pressure classes on request

For questions, please feel free to contact us at: Tel. + 49 281 98 414 - 0