

ELECTROFUSION END CAP

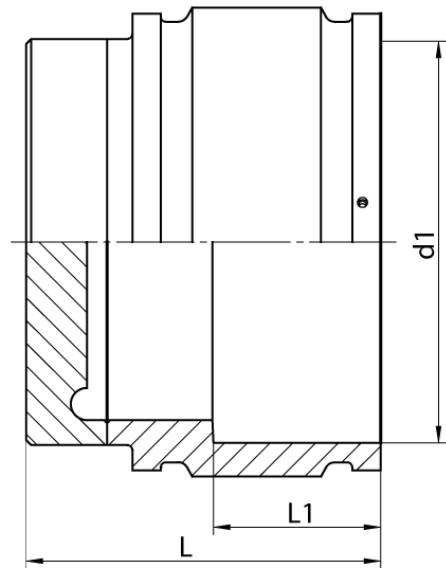

4,0 mm pin

PE100-RC



SDR 11



Art. No.	d1 [mm]	D [mm]	L [mm]	L1 [mm]	kg
4334591104500000	450	560	390	175	35,89

Other materials, dimensions and pressure classes on request

For questions, please feel free to contact us at: Tel. + 49 281 98 414 - 0