

# ELECTROFUSION FULL FACE FLANGE

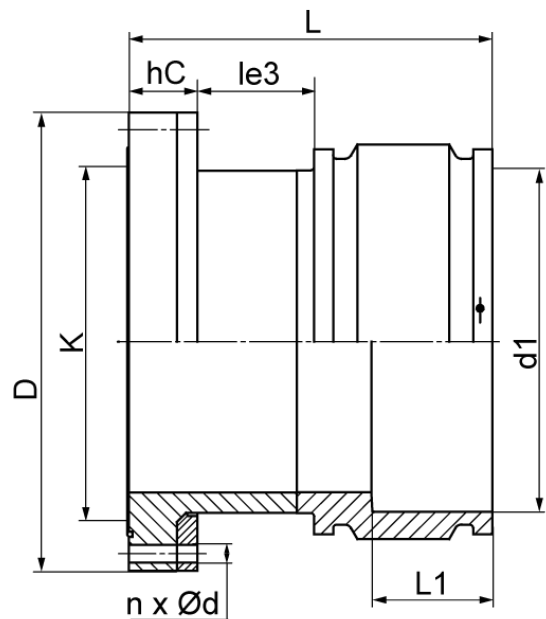

drilled according to DIN EN 1092-1 PN 10  
 with EPDM-O-ring gasket and backing ring steel plastic coated  
 optional with steel hot-dip galvanized or stainless steel backing ring  
 4,0 mm pin

PE100-RC



## SDR 11



Art. No.	DN [mm]	d1 [mm]	D [mm]	le3 [mm]	L [mm]	L1 [mm]	K [mm]	n	Ød [mm]	hC [mm]	kg
4335451107100700	700	710	895	180	675	225	840	24	30	120	190,3

Other materials, dimensions and pressure classes on request

For questions, please feel free to contact us at: Tel. + 49 281  
 98 414 - 0