

# ELECTROFUSION BEND



30°

$r \approx 1,5 \times d$   
two separate welding zones  
4,0 mm pin

PE100-RC

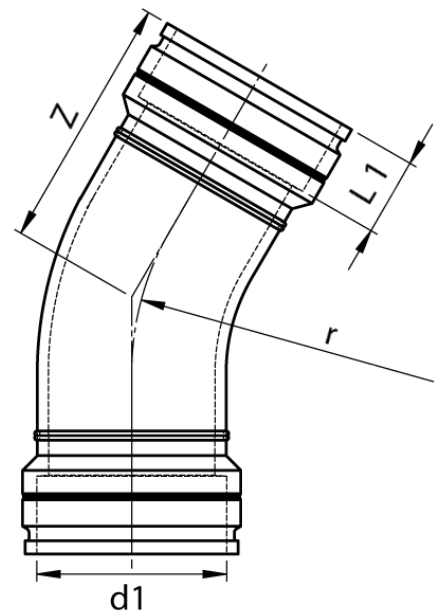

## SDR 11



Art. No.	d1 [mm]	L1 [mm]	z1 [mm]	r [mm]	kg
4336131103150000	315	125	430	496	27,2

tolerance:  $\alpha \pm 5^\circ$  |  $z1 \pm 50$  mm

Other materials, dimensions and pressure classes on request

For questions, please feel free to contact us at: Tel. + 49 281 98 414 - 0