

# ELECTROFUSION STUB END

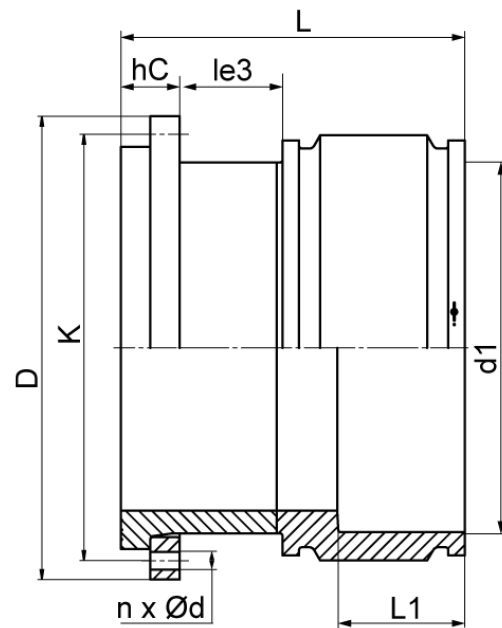

drilled according to DIN EN 1092-1 PN 10  
4,0 mm pin

PE100-RC



## SDR 17



Art. No.	DN [mm]	d1 [mm]	D [mm]	le3 [mm]	L [mm]	L1 [mm]	K [mm]	n	??d [mm]	hC [mm]	kg
4336201706300000	600	630	789	180	590	215	725	20	30	100	112,27

Other materials, dimensions and pressure classes on request

For questions, please feel free to contact us at: Tel. + 49  
281 98 414 - 0