

ELECTROFUSION ELBOW



45°

two separate welding zones from d 200 mm
4,0 mm pin

PE100-RC

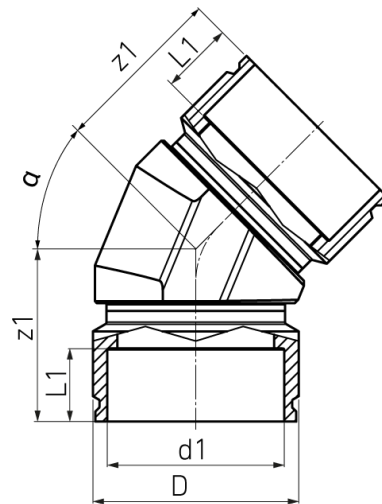

SDR 17



Art. No.	d1 [mm]	D [mm]	L1 [mm]	z1 [mm]	kg
4336341704500000	450	520	175	429	47,9

Tolerance: $\alpha \pm 2^\circ$

Other materials, dimensions and pressure classes on request

For questions, please feel free to contact us at: Tel. + 49 281 98 414 - 0