

two separate welding zones from d 200 mm  
4,0 mm pin

PE100-RC

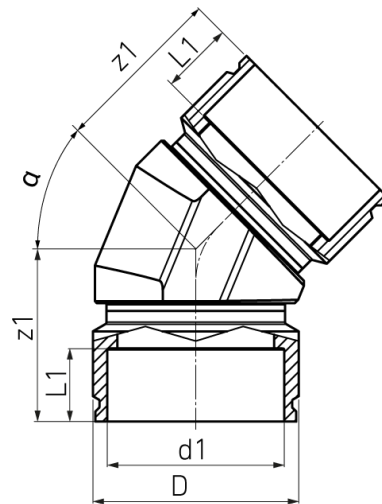

**SDR 17**



Art. No.	d1 [mm]	D [mm]	L1 [mm]	z1 [mm]	kg
4336341709000000	900	1035	260	696	306,2

Tolerance:  $\alpha \pm 2^\circ$

Other materials, dimensions and pressure classes on request

For questions, please feel free to contact us at: Tel. + 49 281 98 414 - 0