

long spigot for butt- and electrofusion welding

PE100-RC

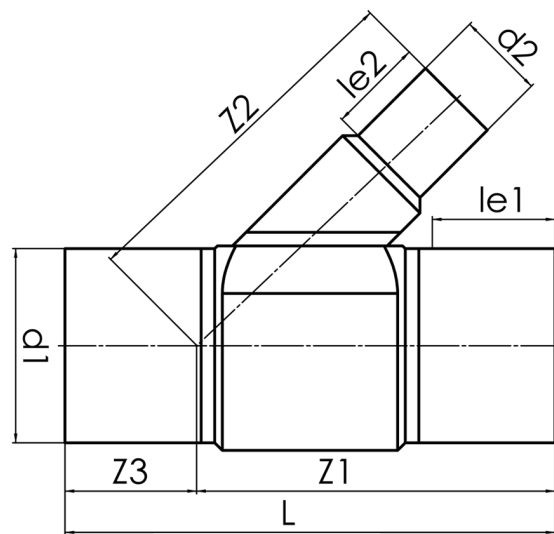

**SDR 11**



Art. No.	d1 [mm]	d2 [mm]	le1 [mm]	le2 [mm]	L [mm]	z1 [mm]	z2 [mm]	z3 [mm]	kg
4342811104000250	400	250	300	129	1205	841	705	364	75,3

Other materials, dimensions and pressure classes on request

For questions, please feel free to contact us at: Tel. + 49 281 98 414 - 0