

TECHNICAL DATA SHEET  
**BRANCH EQUAL**



45°

long spigot for butt- and electrofusion welding  
 welded from pipe, non-reinforced

PE100-RC

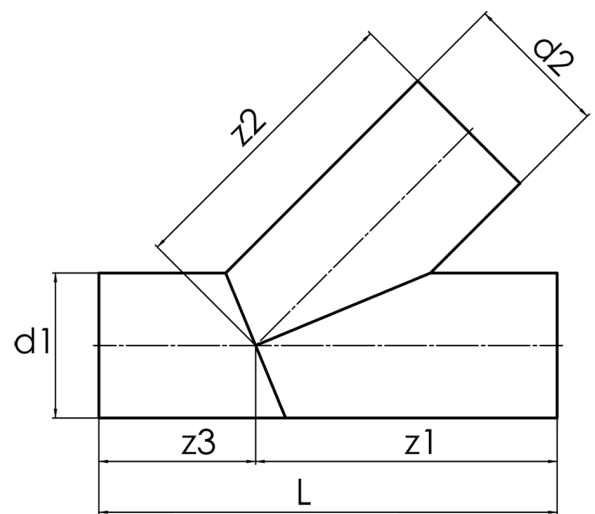

**SDR 17**



Art. No.	d1 [mm]	d2 [mm]	L [mm]	z1 [mm]	z2 [mm]	z3 [mm]	kg
4342851701100110	110	110	556	333	333	223	1,6

Other materials, dimensions and pressure classes on request  
 tolerance + / - 2°

For questions, please feel free to contact us at: Tel. + 49 281 98 414 - 0