

TECHNICAL DATA SHEET
BRANCH EQUAL



60°

long spigot for butt- and electrofusion welding
 welded from pipe, non-reinforced

PE100-RC

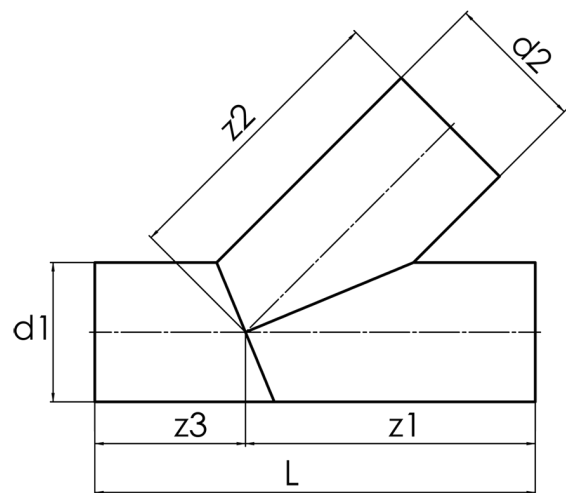

SDR 17



| Art. No. | d1 [mm] | d2 [mm] | L [mm] | z1 [mm] | z2 [mm] | z3 [mm] | kg |
|------------------|------------|------------|-----------|------------|------------|------------|------|
| 4342861704500450 | 450 | 450 | 1220 | 740 | 740 | 480 | 55,7 |

Other materials, dimensions and pressure classes on request
 tolerance + / - 2°

For questions, please feel free to contact us at: Tel. + 49 281 98 414 - 0