

TECHNICAL DATA SHEET  
**BRANCH EQUAL**



60°

long spigot for butt- and electrofusion welding  
 welded from pipe, non-reinforced

PE100-RC

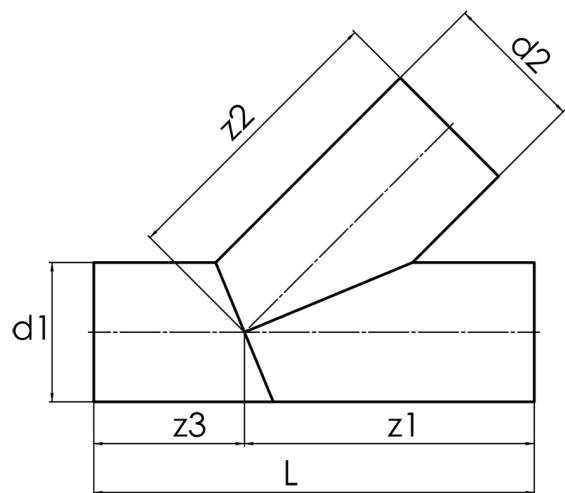

SDR 17



Art. No.	d1 [mm]	d2 [mm]	L [mm]	z1 [mm]	z2 [mm]	z3 [mm]	kg
4342861706300630	630	630	1428	896	896	532	125,1

Other materials, dimensions and pressure classes on request  
 tolerance + / - 2°

For questions, please feel free to contact us at: Tel. + 49 281 98 414 - 0