

to be concret-casted into masonry
with mounted EPDM pipe collar seal

PE100-RC

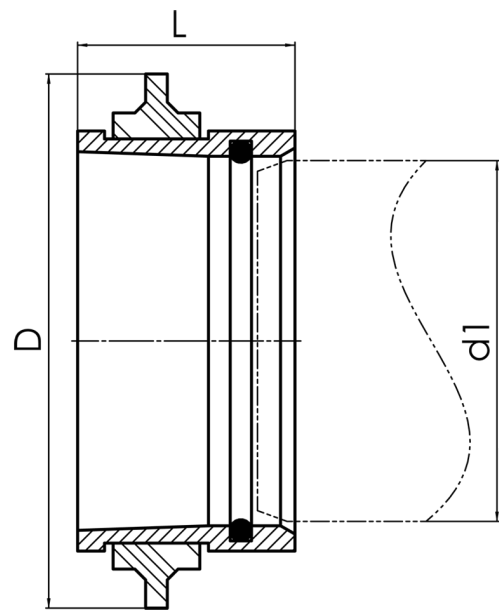

Art. No.	d1 [mm]	D [mm]	L [mm]	kg
4346010002250150	225	350	150	1,2

For questions, please feel free to contact us at: Tel. + 49 281 98 414 - 0