

for use with joint ring (not included)

PE100-RC

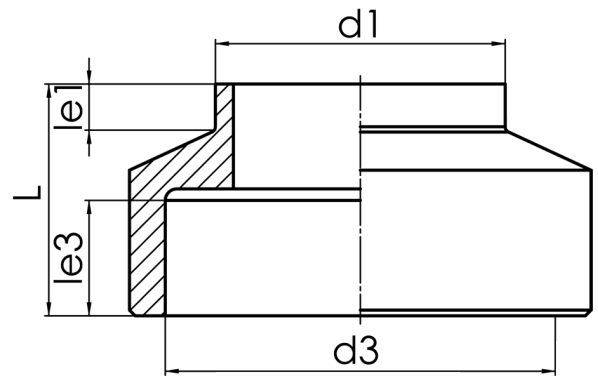

SDR 17



| Art. No. | d1 [mm] | d3 [mm] | le1 [mm] | le3 [mm] | L [mm] | L1 [mm] | kg |
|------------------|------------|------------|-------------|-------------|-----------|------------|-----|
| 4350301701400000 | 140 | 191 | 40 | 100 | 200 | 120 | 3,4 |

For questions, please feel free to contact us at: Tel. + 49 281 98 414 - 0