

for use with joint ring (not included)

PE100-RC

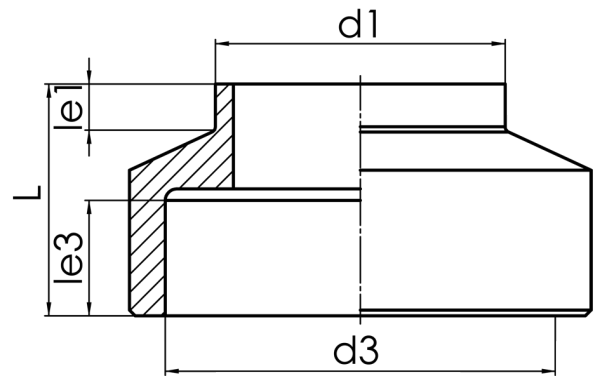

SDR 17



Art. No.	d1 [mm]	d3 [mm]	le1 [mm]	le3 [mm]	L [mm]	L1 [mm]	kg
4350301701600000	160	220	40	100	200	109	2,2

For questions, please feel free to contact us at: Tel. + 49 281 98 414 - 0