

PE100-RC

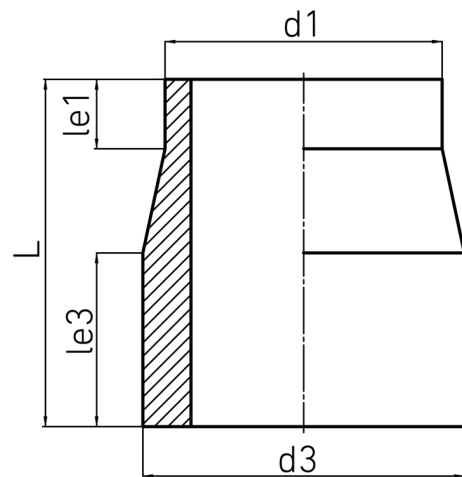

**SDR 11**



Art. No.	d1 [mm]	d3 [mm]	le1 [mm]	le3 [mm]	L [mm]	kg
4350351102000000	200	242	40	100	200	3,8

For questions, please feel free to contact us at: Tel. + 49 281 98 414 - 0