

PE100-RC

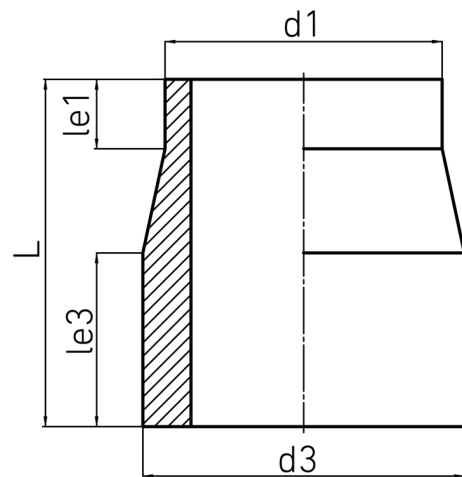

SDR 11



Art. No.	d1 [mm]	d3 [mm]	le1 [mm]	le3 [mm]	L [mm]	kg
4350351102250000	225	242	40	100	200	3,3

For questions, please feel free to contact us at: Tel. + 49 281 98 414 - 0