

TEE FOR CONNECTION TO HYDRANT WITH SPIGOT FOR PRESSURE CONNECTION



Flansch-System

Flange-System
with special/ or KS-flange connection (PN10/PN16) with plastic coated backing ring
available as flange system or with pre-assembled BAIO?? EU-piece
long spigot for butt- and electrofusion welding

PE100-RC

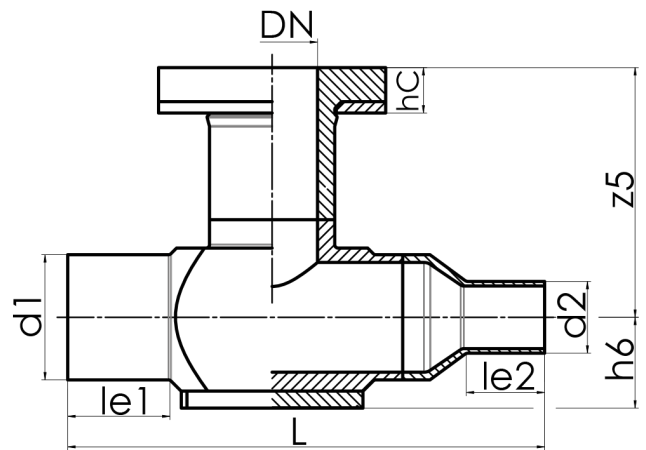

SDR 11



Art. No.	DN [mm]	d1 [mm]	d2 [mm]	le1 [mm]	le1* [mm]	le2 [mm]	L [mm]	z5 [mm]	hC [mm]	kg
4351011100900110	80	90	63	85	350	68	405	210	40	4,87

other dimensions and pressure classes on request

For questions, please feel free to contact us at: Tel. + 49 281 98 414 - 0