

# T-CROSS FOR CONNECTION TO HYDRANT



## Flansch-System

Flange-System  
 with special/ or KS-flange connection (PN10/PN16) with plastic coated backing ring  
 available as flange system or with pre-assembled BAIO?? EU-piece  
 long spigot for butt- and electrofusion welding  
 reinforced

PE100-RC

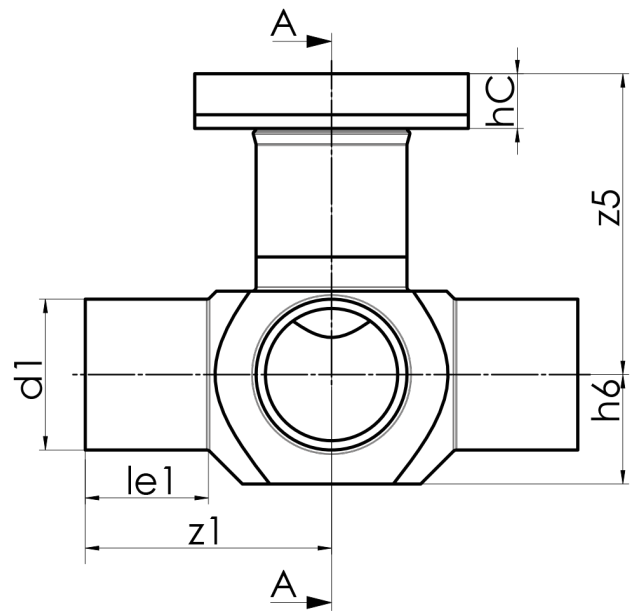

## SDR 17



Art. No.	DN [mm]	d1 [mm]	d2 [mm]	le1 [mm]	le1* [mm]	le2 [mm]	L [mm]	z2 [mm]	h6 [mm]	z5 [mm]	hC [mm]	kg
4351051702250110	80	225	225	130	150	150	570	300	145	275	40	14,71

other dimensions and pressure classes on request

For questions, please feel free to contact us at: Tel.  
 + 49 281 98 414 - 0