

X-CROSS FOR CONNECTION TO HYDRANT



Flansch-System

Flange-System
 with special/ or KS-flange connection (PN10/PN16) with plastic coated backing ring
 available as flange system or with pre-assembled BAIO?? EU-piece
 long spigot for butt- and electrofusion welding
 reinforced

PE100-RC

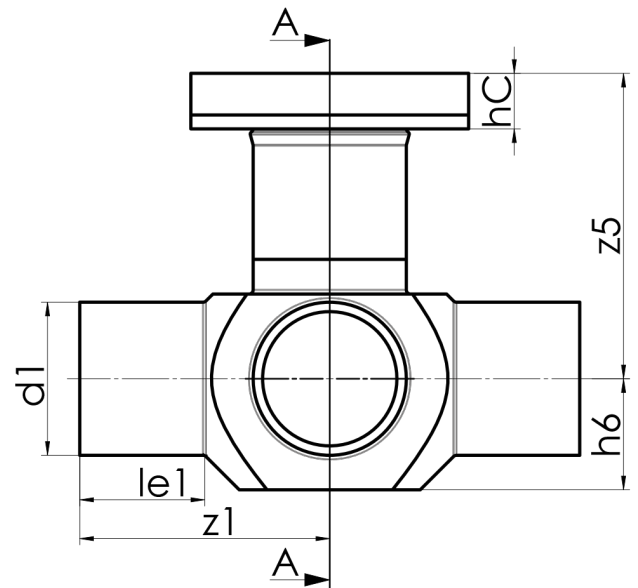

SDR 17



Art. No.	DN [mm]	d1 [mm]	d2 [mm]	le1 [mm]	le1* [mm]	le2 [mm]	z1 [mm]	z2 [mm]	h6 [mm]	z5 [mm]	hC [mm]	kg
4351351701250080	80	125	125	95	150	150	200	250	90	230	40	6,1

other dimensions and pressure classes on request

For questions, please feel free to contact us at: Tel. +
 49 281 98 414 - 0