

**Flansch-System**

Flange-System  
 with special/ or KS-flange connection (PN10/PN16) with plastic coated backing ring  
 available as flange system or with pre-assembled BAIO?? EU-piece  
 long spigot for butt- and electrofusion welding  
 reinforced

PE100-RC

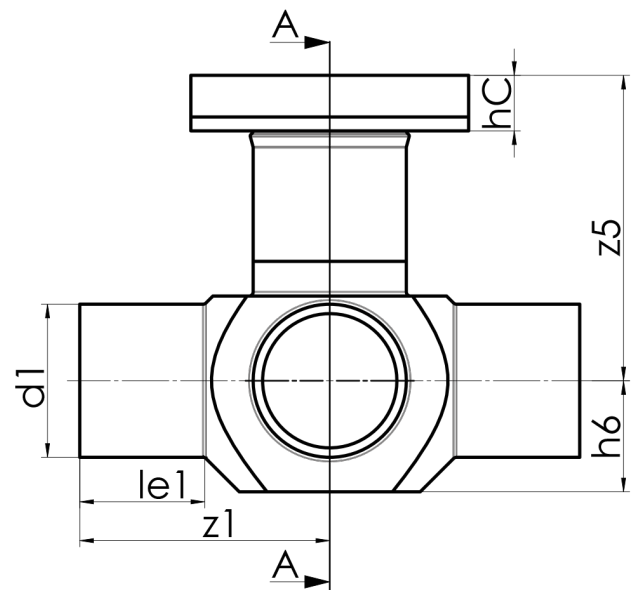

**SDR 17**



Art. No.	DN [mm]	d1 [mm]	d2 [mm]	le1 [mm]	le1* [mm]	le2 [mm]	z1 [mm]	z2 [mm]	h6 [mm]	z5 [mm]	hC [mm]	kg
4351351702000100	100	200	200	120	350	150	260	285	130	260	45	12,4

other dimensions and pressure classes on request

For questions, please feel free to contact us at: Tel.  
 + 49 281 98 414 - 0