

PULL HEAD

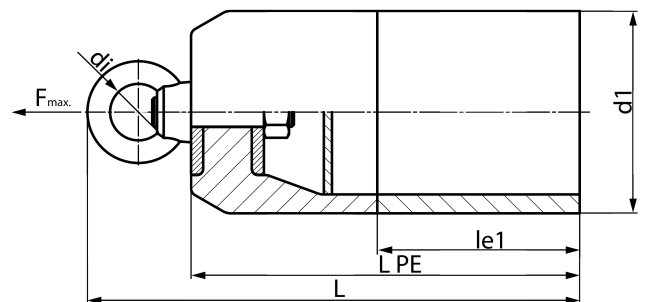

closed version extended with pipe

PE100-RC

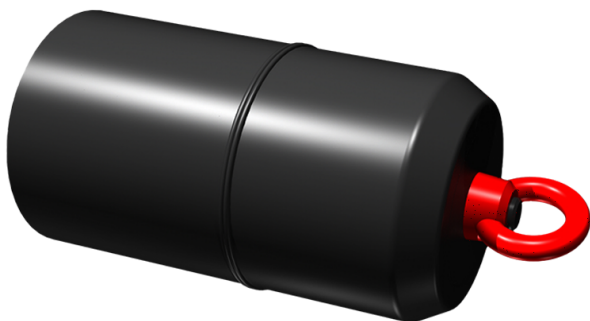

SDR 11

Art. No.	d1 [mm]	le1 [mm]	le1* [mm]	L [mm]	kg
4361051100500000	50	100	100	223	0,38

The towing rope has to be attached to the pull head using a rotating shackle
 Special versions, e.g. for swagelining procedure on request
 other pulling forces on request

For questions, please feel free to contact us at: Tel. + 49 281 98 414 - 0