

closed version

PE100-RC

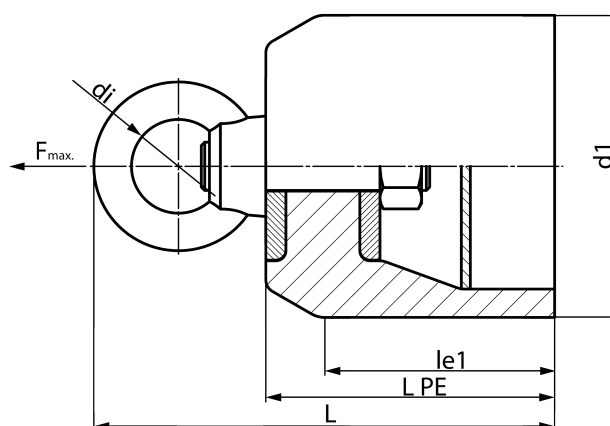
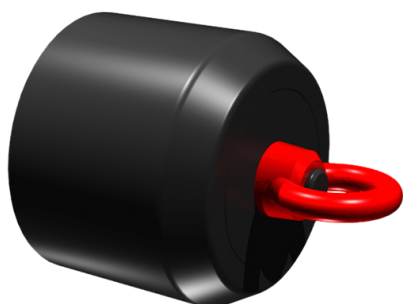

**SDR 11**

Art. No.	d1 [mm]	le1 [mm]	le1* [mm]	L [mm]	kg
4361061100500000	50	55	100	123	0,31

The towing rope has to be attached to the pull head using a rotating shackle  
 Special versions, e.g. for swagelining procedure on request  
 other pulling forces on request

For questions, please feel free to contact us at: Tel. + 49 281 98 414 - 0