

HOLLOW BAR

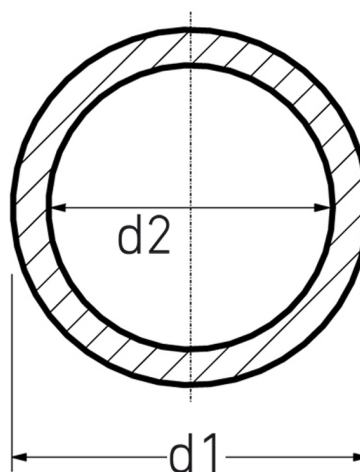

standard length 2.000 mm (pre-cut parts on request)
 fabrication tolerances according to prior agreement

PE100-RC



Art. No.	d1 [mm]	d2 [mm]	kg
4382000001700065	170	65	37,2

Other dimensions and materials on request

For questions, please feel free to contact us at: Tel. + 49 281 98 414 - 0