

HOLLOW BAR

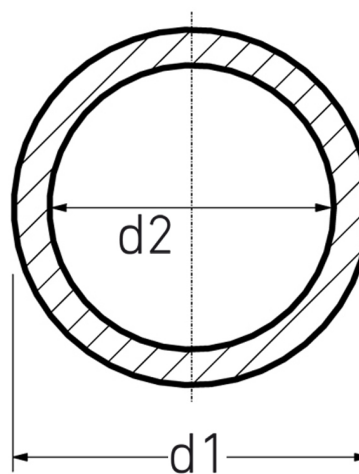

standard length 2.000 mm (pre-cut parts on request)
 fabrication tolerances according to prior agreement

PE100-RC



| Art. No. | d1 [mm] | d2 [mm] | kg |
|------------------|------------|------------|--------|
| 4382000013600750 | 1360 | 750 | 1940,9 |

Other dimensions and materials on request

For questions, please feel free to contact us at: Tel. + 49 281 98 414 - 0