

WALL DUCT WATERTIGHT AND PULL RESISTANT

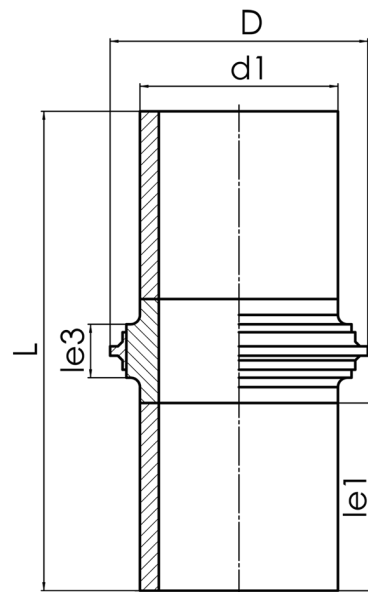

watertight till d 315 mm up to 3 bar, from d 355 mm up to 1 bar

PE100



SDR 11



Art. No.	d1 [mm]	D [mm]	le1 [mm]	le3 [mm]	L [mm]	kg
4412341107100000	710	875	350	85	915	124,9

PP on request
other dimensions and pressure classes on request

For questions, please feel free to contact us at: Tel. + 49 281 98 414 - 0