

two separate welding zones from d 200 mm
4,0 mm pin

PE100

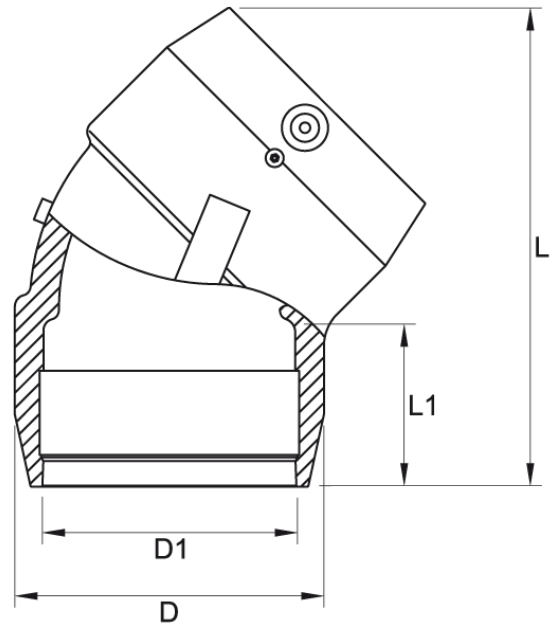

SDR 11



Art. No.	d1 [mm]	D [mm]	L [mm]	L1 [mm]	kg
4414091100750000	75	94	153	53	0,4

Other materials, dimensions and pressure classes on request

For questions, please feel free to contact us at: Tel. + 49 281 98 414 - 0