

ELBOW



90°

long spigot for butt- and electrofusion welding

PE100

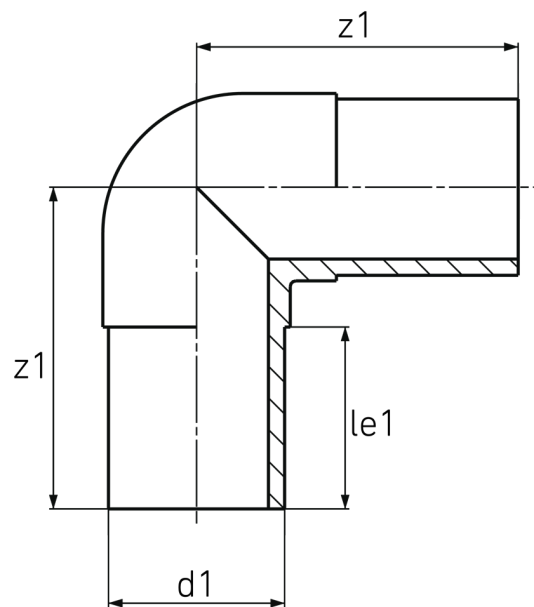

SDR 7,4



Art. No.	d1 [mm]	le1 [mm]	z1 [mm]	kg
4419020700400000	40	59	85	0,1

Tolerance: $\alpha \pm 5^\circ$

For questions, please feel free to contact us at: Tel. + 49 281 98 414 - 0