

90??

two separate welding zones from d 200 mm  
4,0 mm pin

PE100

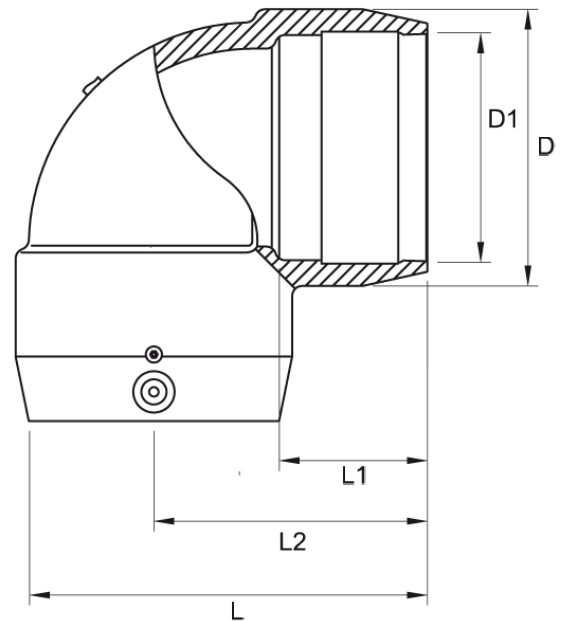

**SDR 11**



Art. No.	d1 [mm]	D [mm]	L [mm]	L1 [mm]	L2 [mm]	kg
4419091101800000	180	222	308	90	197	4,1

Other materials, dimensions and pressure classes on request

For questions, please feel free to contact us at: Tel. + 49 281 98 414 - 0