

r = 1 x d
 injection moulded
 short spigot for butt welding

PE100

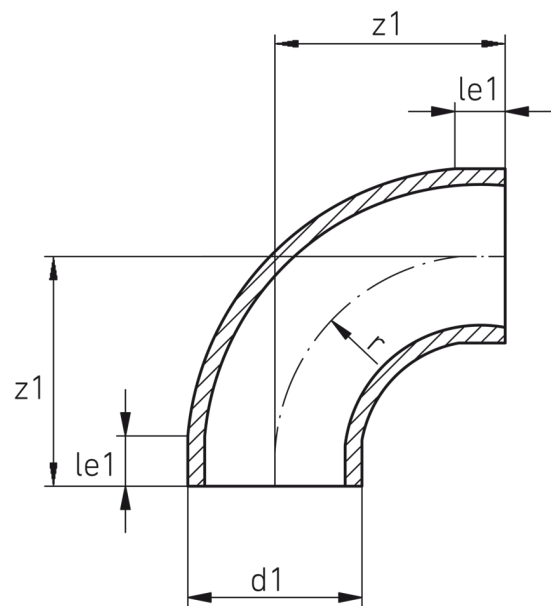

SDR 11



Art. No.	d1 [mm]	le1 [mm]	z1 [mm]	r [mm]	kg
4419901101250000	125	15	140	125	1

Other materials on request

For questions, please feel free to contact us at: Tel. + 49 281 98 414 - 0