

SEAMLESS BEND



90??

$r = 1 \times d$
 injection moulded
 short spigot for butt welding

PE100

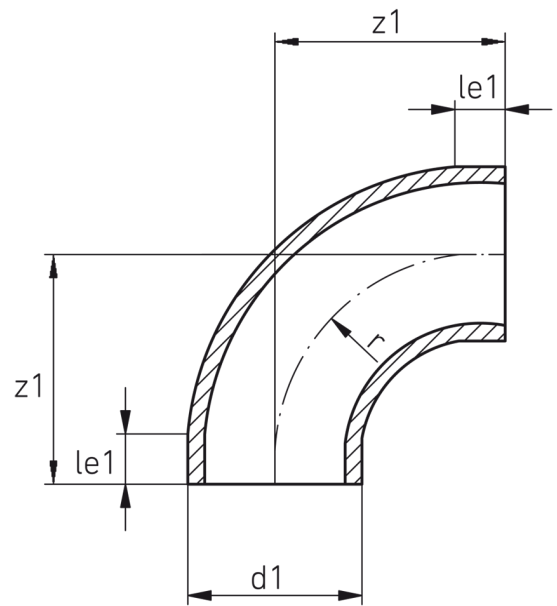

SDR 33



Art. No.	d1 [mm]	le1 [mm]	z1 [mm]	r [mm]	kg
4419903302800000	280	10	290	280	3,4

Other materials on request

For questions, please feel free to contact us at: Tel. + 49 281 98 414 - 0