

TEE REDUCED

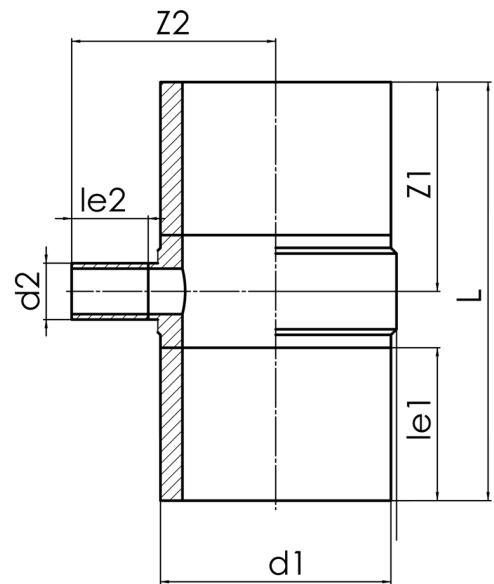

long spigot for butt- and electrofusion welding

PE100



SDR 17



Art. No.	d1 [mm]	d2 [mm]	le1 [mm]	le2 [mm]	L [mm]	z1 [mm]	z2 [mm]	kg
4432301708000125	800	125	350	150	970	485	581	113,94

Other materials, dimensions and pressure classes on request

For questions, please feel free to contact us at: Tel. + 49 281 98 414 - 0