

# TEE REDUCED

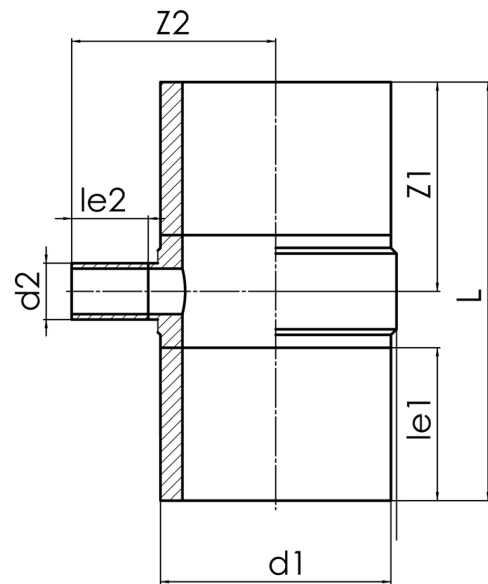

long spigot for butt- and electrofusion welding

PE100



## SDR 17



Art. No.	d1 [mm]	d2 [mm]	le1 [mm]	le2 [mm]	L [mm]	z1 [mm]	z2 [mm]	kg
4432301708000710	800	710	350	350	1560	780	781	235,8

Other materials, dimensions and pressure classes on request

For questions, please feel free to contact us at: Tel. + 49 281 98 414 - 0