

TEE REDUCED

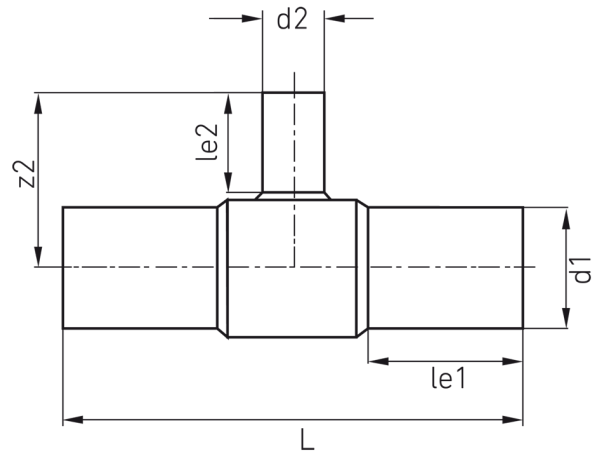

long spigot for butt- and electrofusion welding

PE100



SDR 17



Art. No.	d1 [mm]	d2 [mm]	le1 [mm]	le2 [mm]	L [mm]	z2 [mm]	kg
4432501701800160	180	160	105	94	411	205	3,6

Other materials and pressure classes on request

For questions, please feel free to contact us at: Tel. + 49 281 98 414 - 0