

# ELECTROFUSION TEE, EQUAL

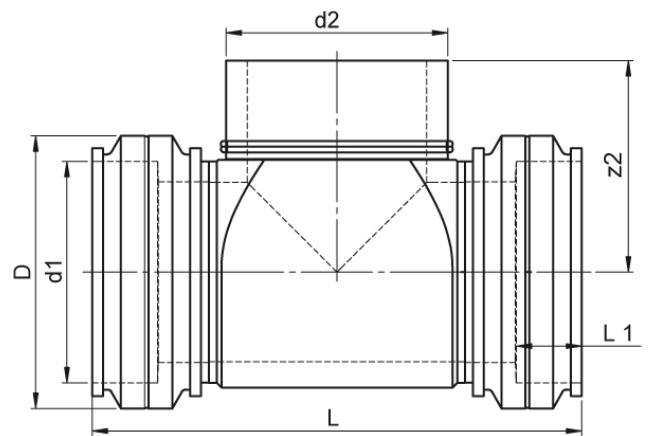

two separate welding zones from d 200 mm  
4,0 mm pin

PE100



## SDR 11



Art. No.	d1 [mm]	D [mm]	L [mm]	L1 [mm]	z2 [mm]	kg
4432601101100000	110	139	239	73	157	1,7

Other materials, dimensions and pressure classes on request

For questions, please feel free to contact us at: Tel. + 49 281 98 414 - 0