

# ELECTROFUSION TEE, EQUAL

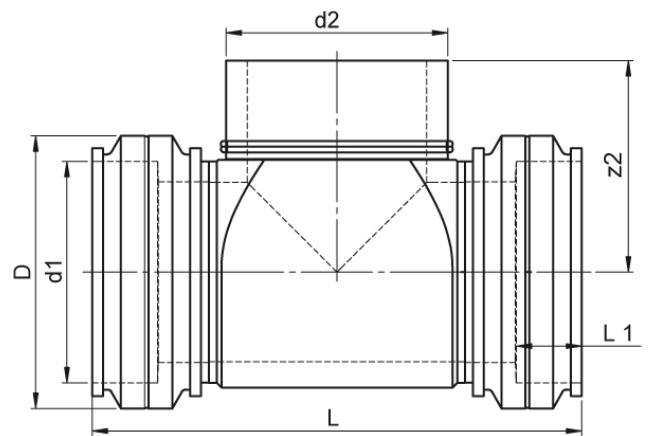

two separate welding zones from d 200 mm  
4,0 mm pin

PE100-RC



## SDR 17



Art. No.	d1 [mm]	D [mm]	L [mm]	L1 [mm]	z2 [mm]	kg
4432701704000000	400	463	1060	165	565	58,6

Other materials, dimensions and pressure classes on request

For questions, please feel free to contact us at: Tel. + 49 281 98 414 - 0