

REDUCER CONCENTRIC

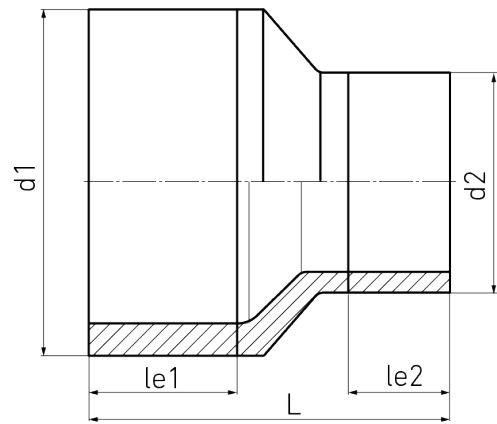

long spigot for butt- and electrofusion welding

PE100



SDR 11



Art. No.	d1 [mm]	d2 [mm]	le1 [mm]	le2 [mm]	L [mm]	kg
4434131107100500	710	500	350	350	890	91,8

Other materials, dimensions and pressure classes on request

For questions, please feel free to contact us at: Tel. + 49 281 98 414 - 0