

two separate welding zones from d 200 mm  
4,0 mm pin

PE100

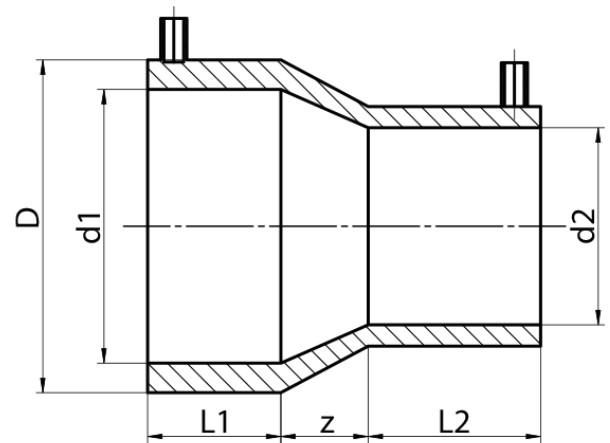

**SDR 11**



Art. No.	d1 [mm]	d2 [mm]	D1 [mm]	D2 [mm]	L [mm]	L1 [mm]	L2 [mm]	kg
4434501100630040	63	40	78	52	102	52	45	0,1

Other materials, dimensions and pressure classes on request

For questions, please feel free to contact us at: Tel. + 49 281 98 414 - 0