

ELECTROFUSION BEND



22°

$r \approx 1,5 \times d$
two separate welding zones
4,0 mm pin

PE100

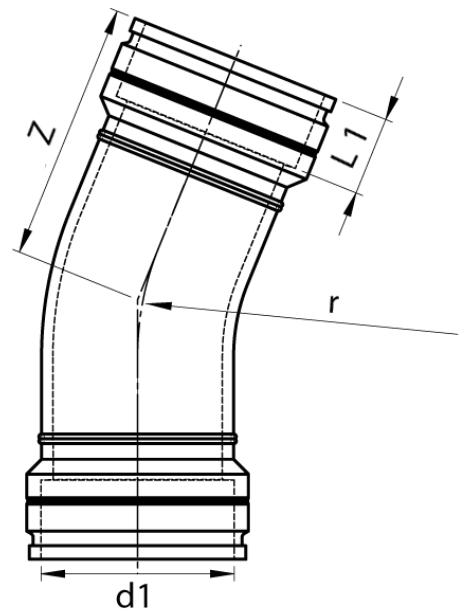

SDR 11



Art. No.	d1 [mm]	L1 [mm]	z1 [mm]	r [mm]	kg
4436121109000000	900	260	945	1430	482,5

tolerance: $\alpha \pm 5^\circ$ | $z1 \pm 50$ mm

Other materials, dimensions and pressure classes on request

For questions, please feel free to contact us at: Tel. + 49 281 98 414 - 0