

drilled according to DIN EN 1092-1 PN 10
4,0 mm pin

PE100-RC

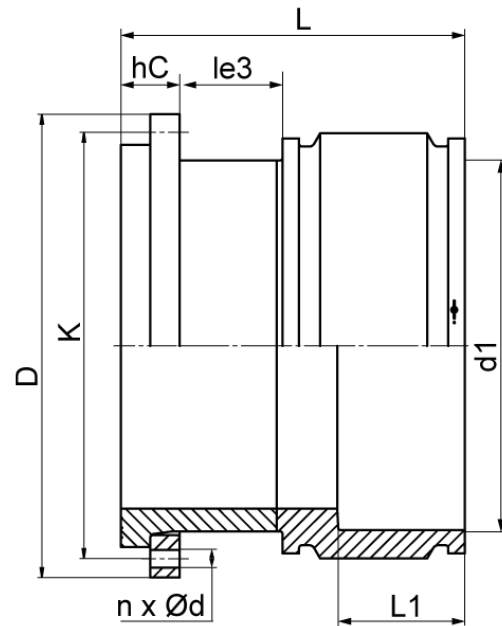

SDR 17



Art. No.	DN [mm]	d1 [mm]	D [mm]	L [mm]	L1 [mm]	K [mm]	n	??d [mm]	hC [mm]	kg
4436201702500250	250	250	406	270	120	350	12	22	51	19,54

Other materials, dimensions and pressure classes on request

For questions, please feel free to contact us at: Tel. + 49 281 98 414
- 0