

END CAP

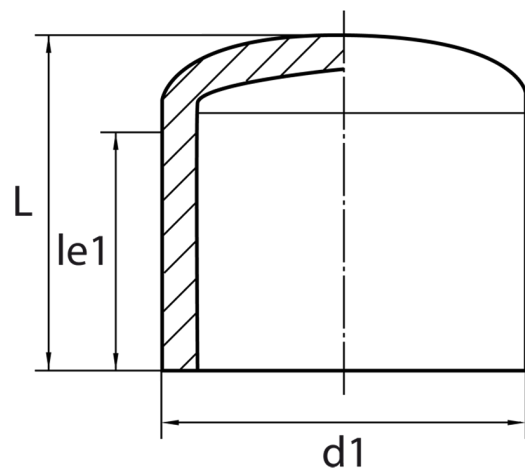

long spigot for butt- and electrofusion welding

PE100

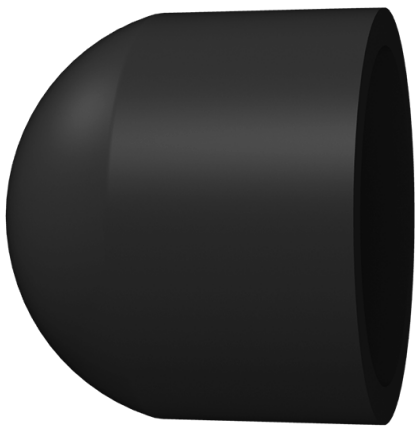

SDR 7,4



Art. No.	d1 [mm]	le1 [mm]	L [mm]	kg
4445020800750000	75	74	89	0,2

Other materials and pressure classes on request

For questions, please feel free to contact us at: Tel. + 49 281 98 414 - 0