

BALLOON SADDLE

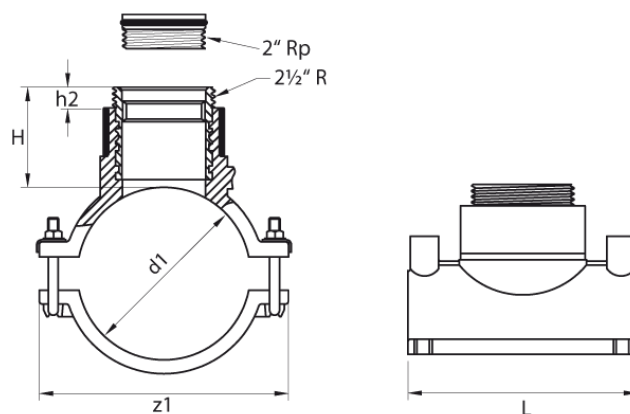

outlet with male thread
 4 mm Pin
 Supplied as a kit consisting of: Balloon Saddle, plug and cap
 Pressure ratings: Water PN 16 / Gas 10 bar

PE100



Art. No.	d1 [mm]	L [mm]	z1 [mm]	H [mm]	h2 [mm]	VE	kg
4470101102500212	250	166	317	86	15	2	3,77

For questions, please feel free to contact us at: Tel. + 49 281 98 414 - 0