

TAPPING TEE FOR HOUSE CONNECTIONS AND DISTRIBUTION LINES

4 mm Pin
to be processed with standard 12 mm hexagonal drives
pressure ratings: water 16 bar / gas 10 bar

PE100

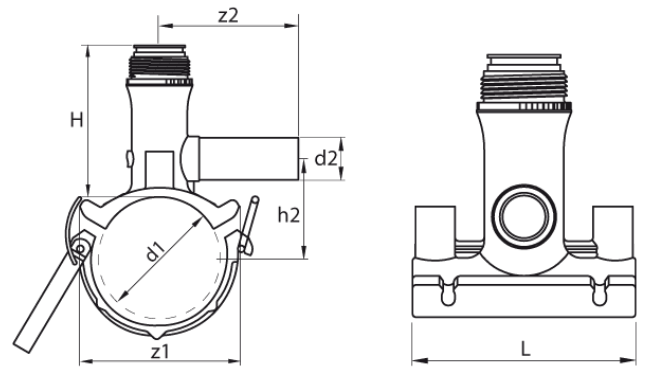

Art. No.	d1 [mm]	d2 [mm]	L [mm]	z2 [mm]	H [mm]	h2 [mm]	VE	kg
4470601100500032	50	32	120	105	110	50	10	0,4

* Tapping tees for 63 mm mains only are not suitable for SDR 17 pressurised pipe applications

For questions, please feel free to contact us at: Tel. + 49 281 98 414 - 0