

# TAPPING TEE FOR HOUSE CONNECTIONS AND DISTRIBUTION LINES

4 mm Pin  
to be processed with standard 12 mm hexagonal drives  
pressure ratings: water 16 bar / gas 10 bar

PE100

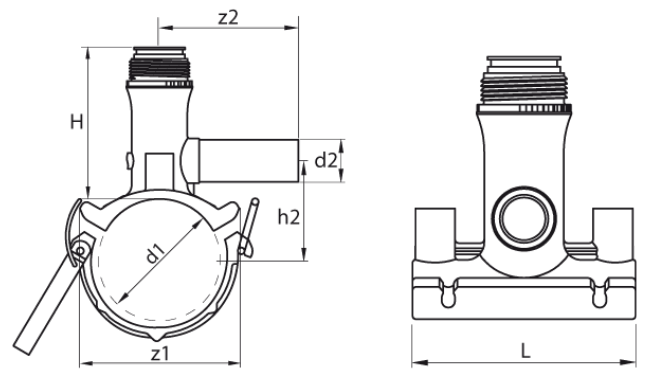

Art. No.	d1 [mm]	d2 [mm]	L [mm]	z2 [mm]	H [mm]	h2 [mm]	VE	kg
4470601100750040	75	40	146	165	152	57	5	1,1

\* Tapping tees for 63 mm mains only are not suitable for SDR 17 pressurised pipe applications

For questions, please feel free to contact us at: Tel. + 49 281 98 414 - 0