

Außengewinde

PE 100

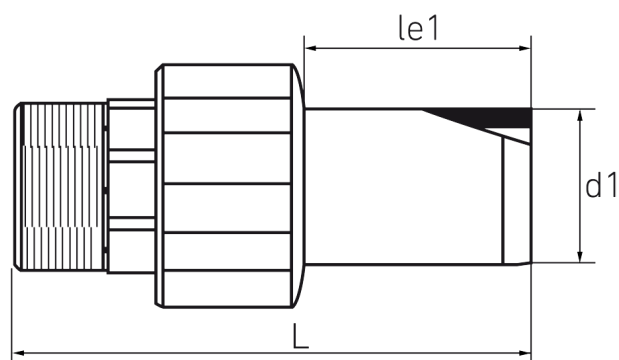

SDR 11



Art. Nr.	d1 [mm]	R [mm]	le1 [mm]	L [mm]	kg
18302342	25	3/4"	45	94	0,2

Bei Fragen wenden Sie sich gerne an uns: Tel. + 49 281 98 414 - 0