

Außengewinde

PE100

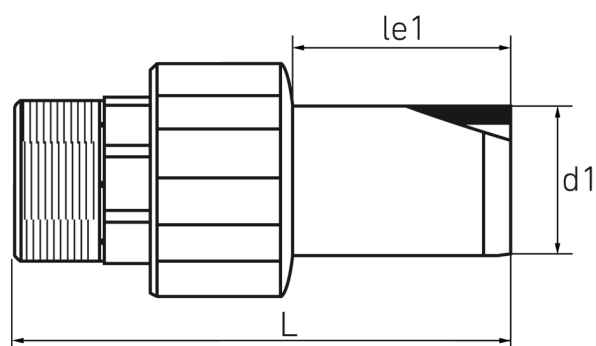

## SDR 11

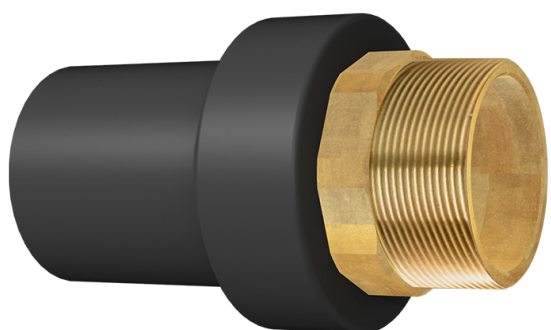

Art. Nr.	d1 [mm]	le1 [mm]	L [mm]	kg
4150401100750000	75	76	156	1,2

Lieferprogramm:  
SDR11: d 20 - 125 mm

Bei Fragen wenden Sie sich gerne an uns: Tel. + 49 281 98 414 - 0