

zwei separate Schweißzonen ab d 200 mm
4,0 mm Steckkontakt

PE100-RC

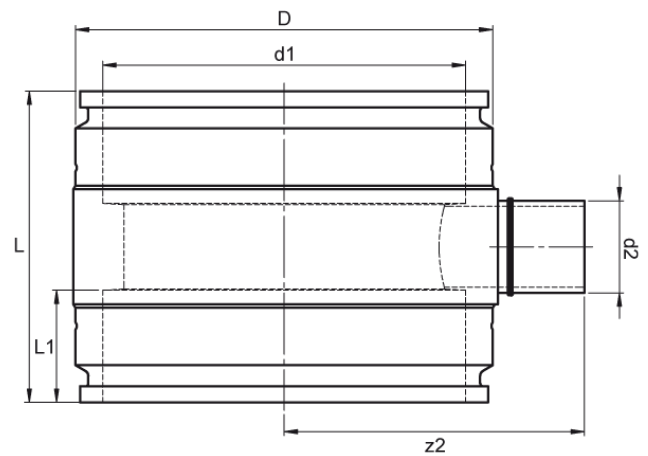

SDR 11



Art. Nr.	d1 [mm]	d2 [mm]	D [mm]	le2 [mm]	L [mm]	L1 [mm]	z2 [mm]	kg
4332701104000075	400	75	499	100	415	165	380	31,40

Andere Materialien, Abmessungen und Druckstufen auf Anfrage
Lieferprogramm:
SDR17: d 400 - 1200 mm | SDR11: d 20 - 900 mm

Bei Fragen wenden Sie sich gerne an uns: Tel. + 49 281 98 414 - 0